

SAFETY INFORMATION

Released Date: 2024-09-16

Please read and understand this entire manual before attempting to assemble, install or operate the product.

WARNING

- RISK OF ELECTRIC SHOCK - Before beginning installation, turn off electricity at the circuit breaker box or the main fuse box.
- RISK OF FIRE - Use bulbs specified by the markings and/or labels on the fixture.

CAUTION

- For your safety, read instructions completely before beginning installation.
- If in doubt about electrical installation, consult a licensed electrician.
- Turn off electricity to fixture before replacing the bulb(s).

TOOLS REQUIRED

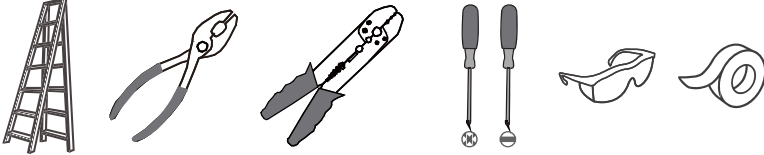

CARE AND MAINTENANCE

- Wipe clean using soft, dry cloth or static duster. Always avoid using harsh chemicals and abrasives to clean fixture as they may damage the finish.

If you need further assistance call Quozel Customer Care at 1-800-645-3184 (9:00am - 5:00pm EST), or visit us on-line at www.quezel.com.

PACKAGE CONTENTS

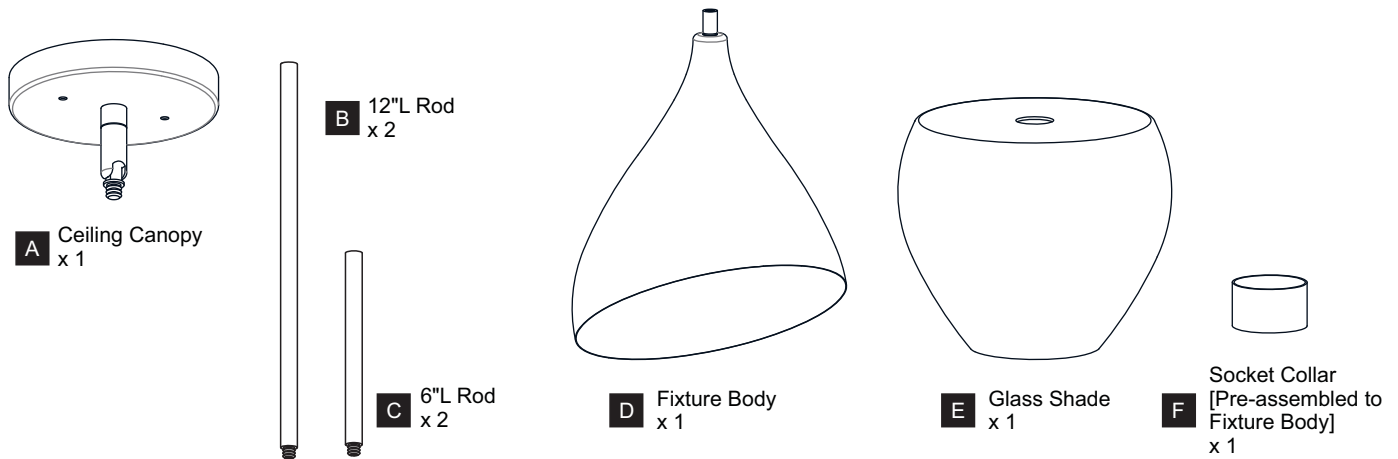

MOUNTING HARDWARE

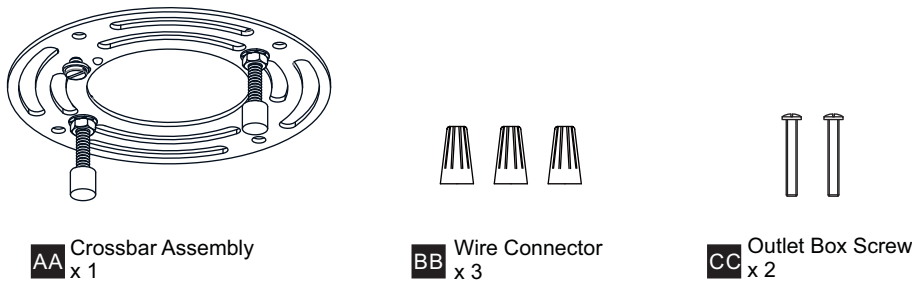

INSTALLATION

1 Install Rods

Optional Rods:

- 8 Feet Ceiling:
(1) 12"L Rod.
- 9 Feet Ceiling:
(2) 12"L Rods.
- 10 Feet Ceiling:
(2) 6"L Rods + (2) 12"L Rods.

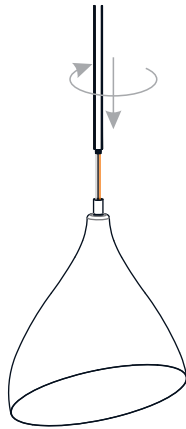
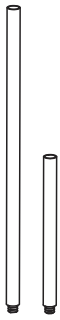

2 Install Ceiling Canopy to Upper Rod

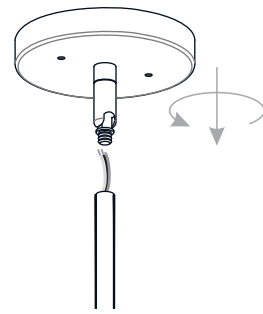

3 Install Crossbar Assembly

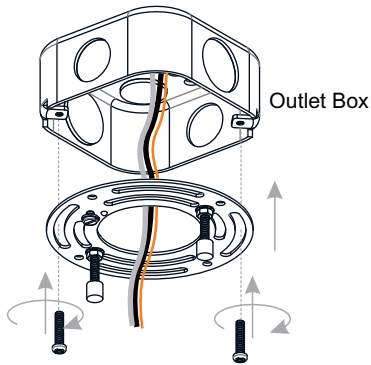

4 Wiring

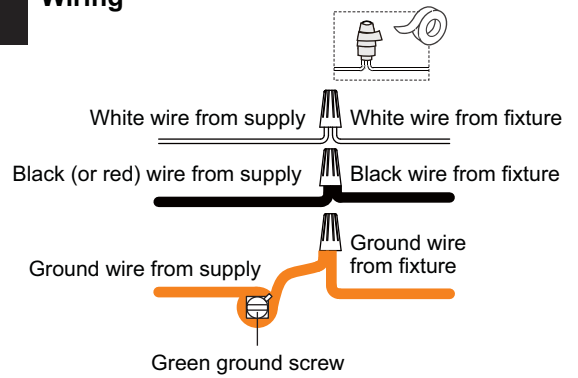

5 Install Ceiling Canopy to Crossbar Assembly

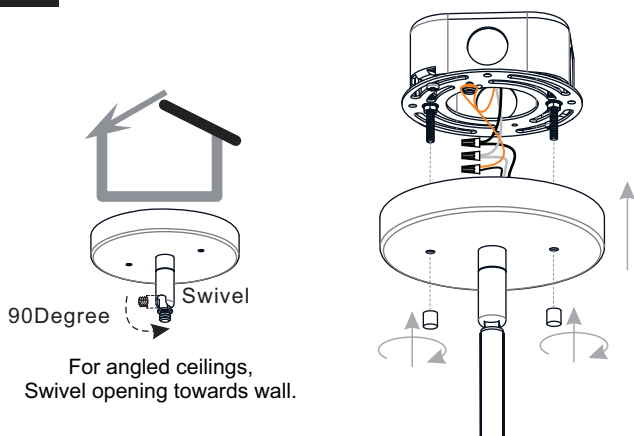

6 Install Glass Shade

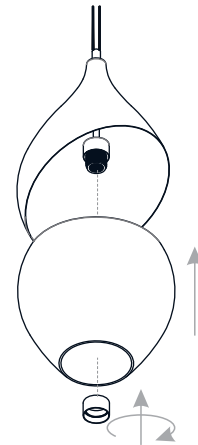

7 Install Bulb

Install the correct bulb referring to fixture markings and/or labels for maximum wattage.

Recommended Bulb type (not included):

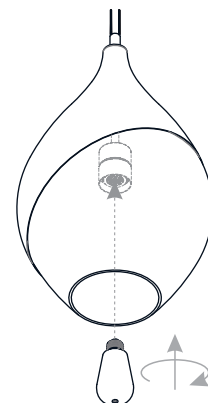

Your installation is now complete! Restore electricity and save this sheet for future reference.